

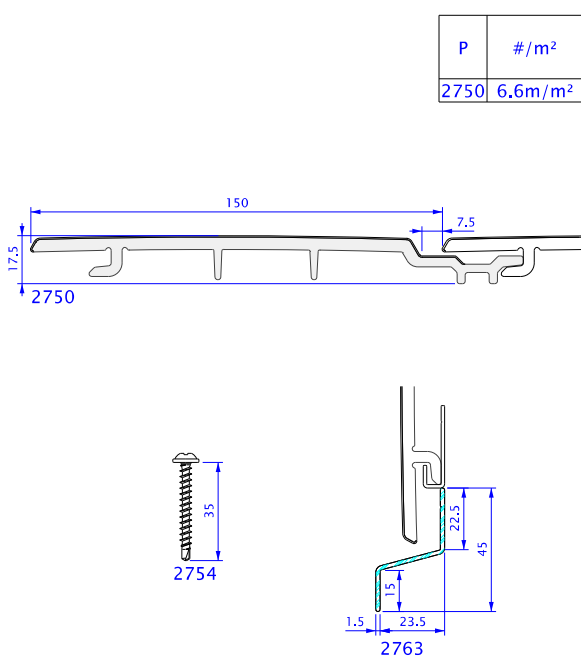

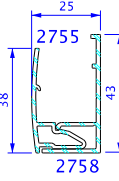

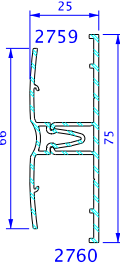
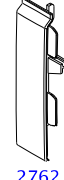
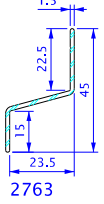
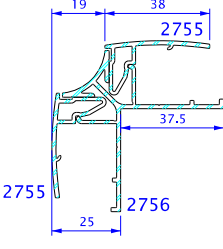
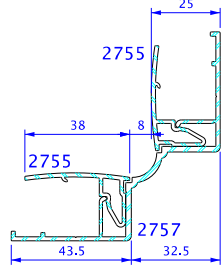
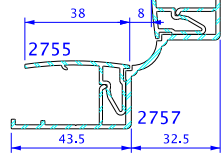
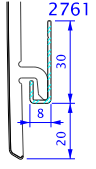
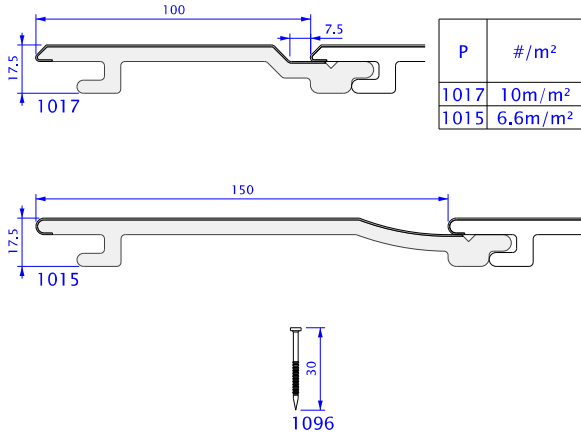
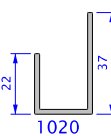
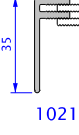

									
<p>BELFACE</p> <table border="1"> <thead> <tr> <th>P</th> <th>#/m²</th> </tr> </thead> <tbody> <tr> <td>2750</td> <td>6.6m/m²</td> </tr> </tbody> </table> 	P	#/m ²	2750	6.6m/m ²	   	  								
P	#/m ²													
2750	6.6m/m ²													
<p>DEEPLAS</p> <table border="1"> <thead> <tr> <th>P</th> <th>#/m²</th> </tr> </thead> <tbody> <tr> <td>1017</td> <td>10m/m²</td> </tr> <tr> <td>1015</td> <td>6.6m/m²</td> </tr> </tbody> </table> 	P	#/m ²	1017	10m/m ²	1015	6.6m/m ²	 	   	  					
P	#/m ²													
1017	10m/m ²													
1015	6.6m/m ²													
<p>MURVINYL</p> <table border="1"> <thead> <tr> <th>P</th> <th>#/m²</th> </tr> </thead> <tbody> <tr> <td>107</td> <td>10m/m²</td> </tr> <tr> <td>180</td> <td>10m/m²</td> </tr> <tr> <td>126</td> <td>6m/m²</td> </tr> <tr> <td>130</td> <td>6m/m²</td> </tr> </tbody> </table> 	P	#/m ²	107	10m/m ²	180	10m/m ²	126	6m/m ²	130	6m/m ²	  	 	  	 
P	#/m ²													
107	10m/m ²													
180	10m/m ²													
126	6m/m ²													
130	6m/m ²													

Alle gegevens zijn ter goede trouw en weerspiegelen onze huidige kennis. Zij kunnen deels niet tegen ons gebruikt worden. Technische wijzigingen voorbehouden.
 Tous les renseignements donnés reflètent l'état actuel de nos connaissances et ne peuvent en aucun cas être retenus contre nous. Modifications techniques réservées.

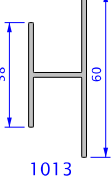
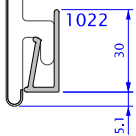
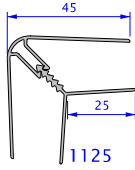
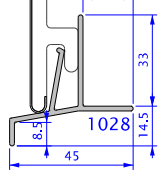
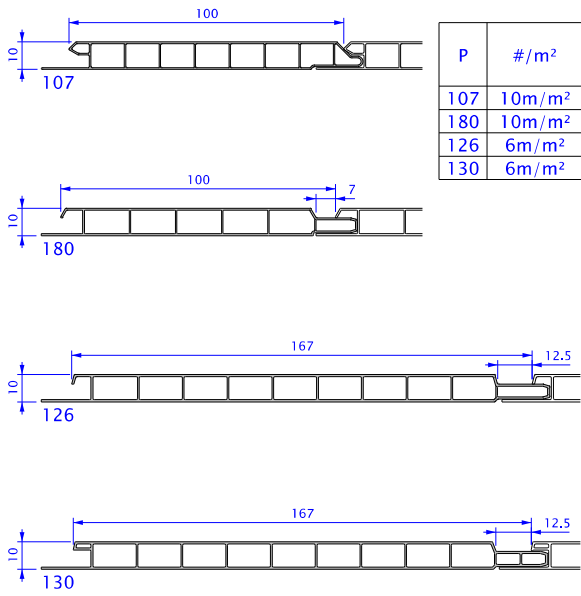
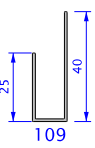

DEEPLAS

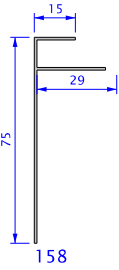
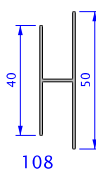
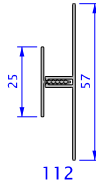
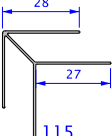
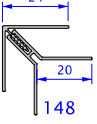
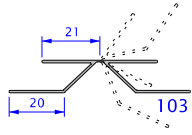
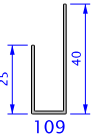
SERIE			
1030	1156 500mm sym	1157 300mm 300mm	1155 500mm sym
1080	1067 250mm		1066 250mm
1400	1406 500mm sym		1408 500mm sym
	1407 300mm		

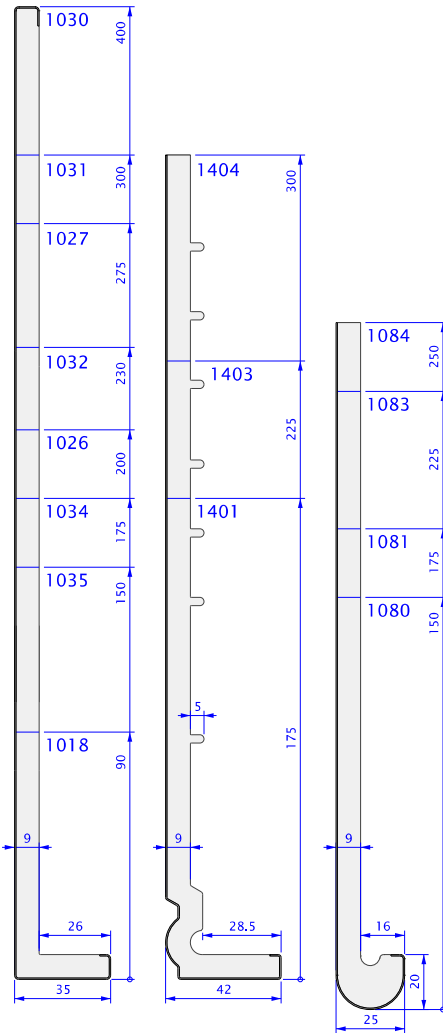
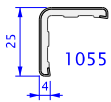
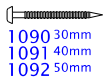

MURVINYL

P			
104	160	162	161
131	157	178	177
133	166		
156	157	178	177
183	157	178	177
185	160	162	161

157, 177, 178 = 480mm

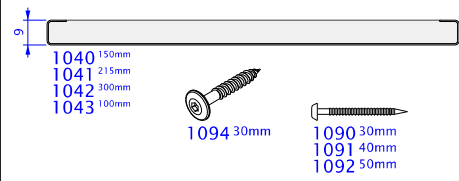
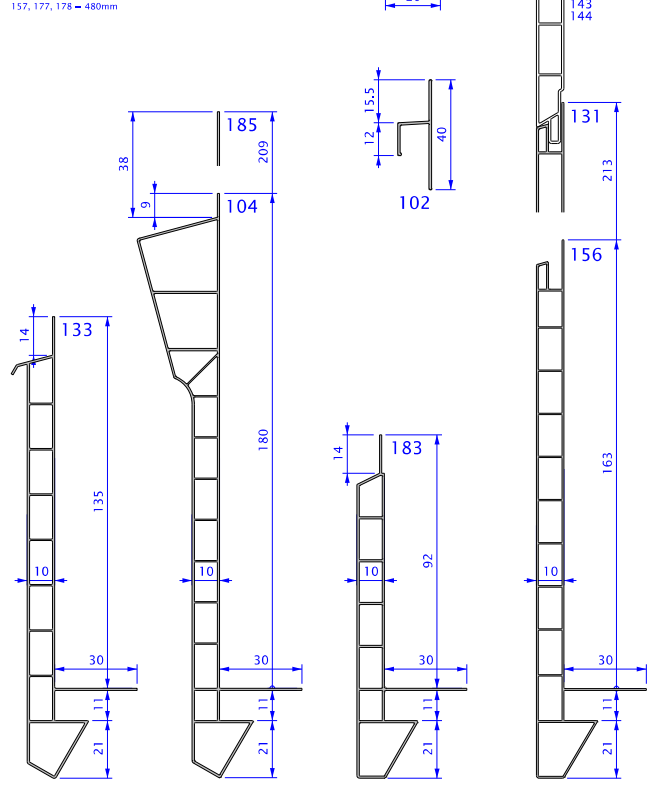

SERIE	
1040	1160 437mm sym

P	#/m ²
107	10m/m ²
118	8m/m ²
126	6m/m ²
130	6m/m ²
135	5m/m ²
143	10m/m ²
144	6m/m ²
145	4m/m ²
180	10m/m ²

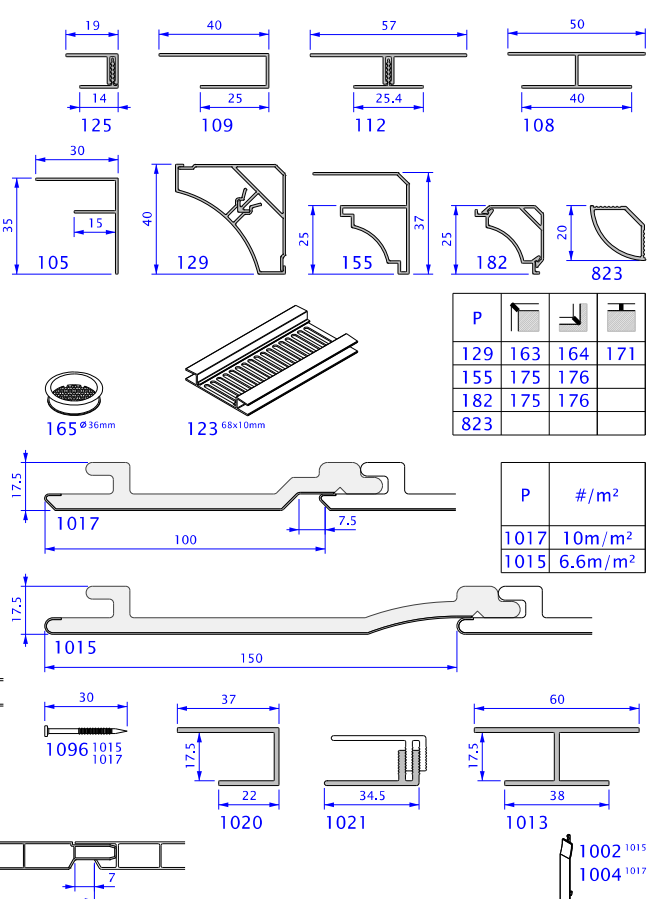
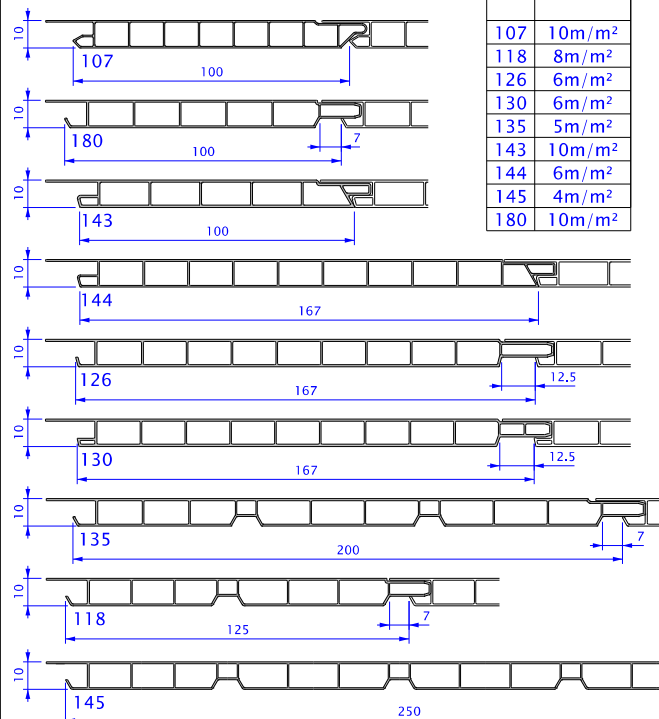

Alle gegevens zijn ter goede trouw en weerspiegelen onze huidige kennis. Zij kunnen derhalve niet tegen ons gebuikt worden. Technische wijzigingen voorbehouden.
 Tous les renseignements donnés reflètent l'état actuel de nos connaissances et ne peuvent en aucun cas être retenus contre nous. Modifications techniques réservées.

BEE_BO

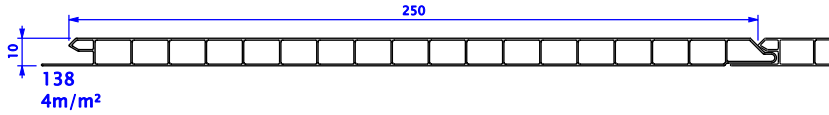

VERMONT

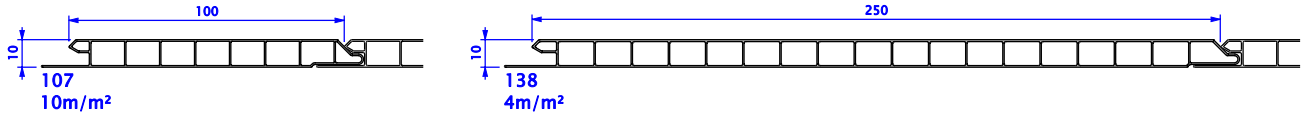

PRIMA VERA

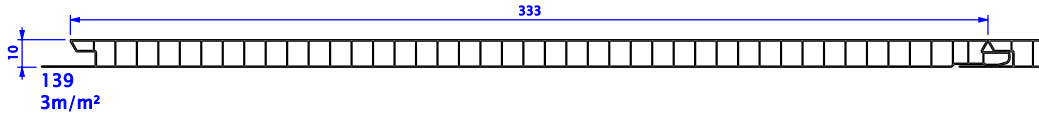

SCARLET

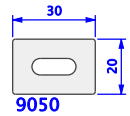
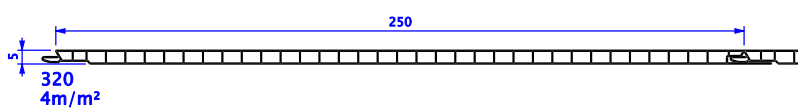

						SCARLET	
		25	14			14	
		40	19			19	
		109	125			70	
		40	25				
		50	57				
		108	112				
		28	24			21	
		27	20			20	
		115	148			103	
				15.5			
				26			
				79			
				23			
				13			
		24	11.5			1.8	
		197	147			25	
		45	32.5			78	
				25		34	
						472	

PLINTEN EN SIERLIJSTEN / PLINTHES ET MOULURES

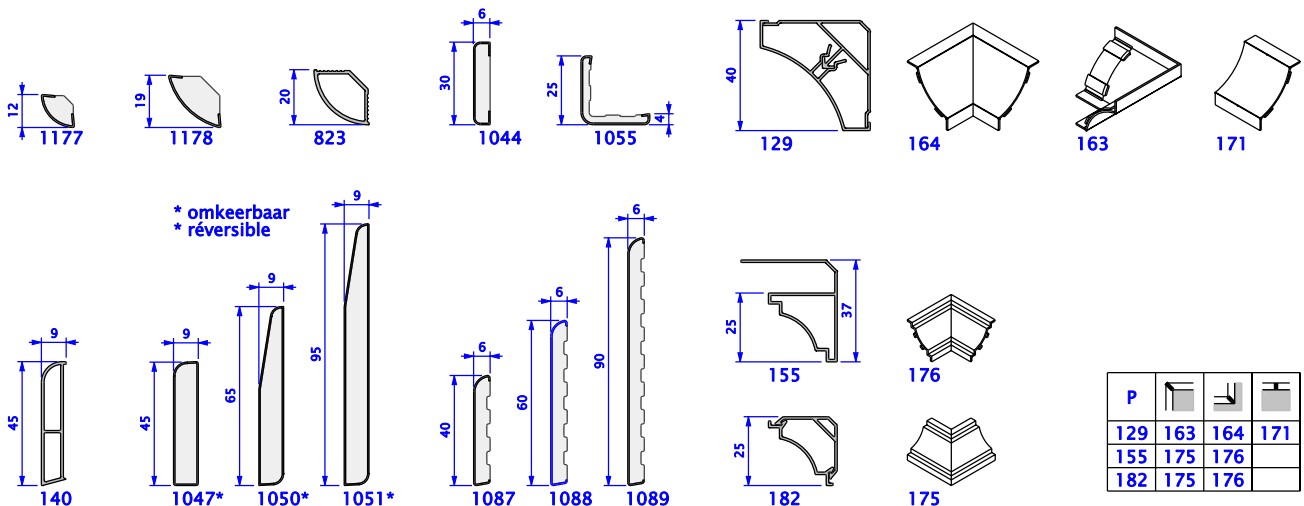

P				
129	163	164	171	
155	175	176		
182	175	176		

Alle gegevens zijn ter goede trouw en weerspiegelen onze huidige kennis. Zij kunnen deeltijde niet tegen ons gebruikt worden. Technische wijzigingen voorbehouden. / Tous les renseignements donnés réfèrent l'état actuel de nos connaissances et ne peuvent en aucun cas être retenus contre nous. Modifications techniques réservées.



O-WALL

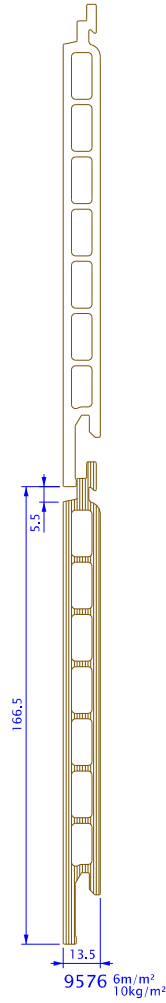

P	#/m ²	
9488	12/m ²	
9576	6m/m ²	10kg/m ² 10kg/m ²

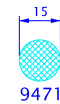
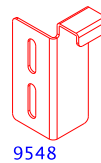
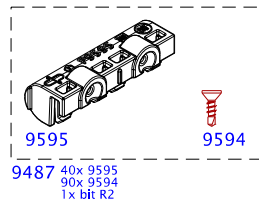
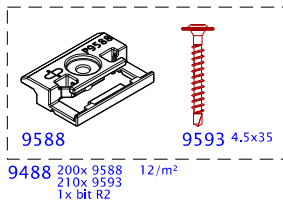
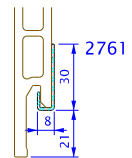
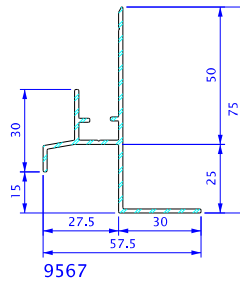
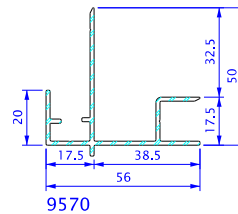
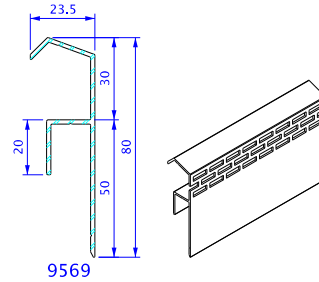
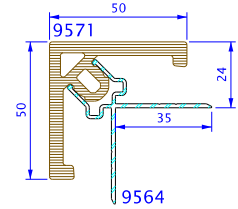
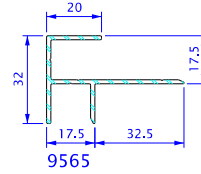
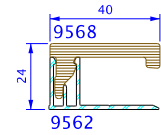
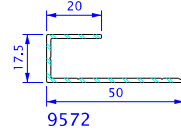

OPEN GEVELBEKLEDING BARDAGE AJOURÉ

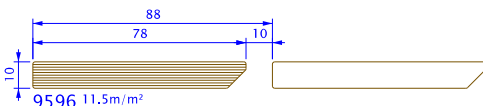

P	#/m ²	
2753	33/m ²	
2754	33/m ²	
9593	33/m ²	
9596	11.5m/m ²	11.5kg/m ²
9598	3.3m/m ²	1.6kg/m ² 13.1kg/m ²

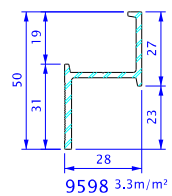
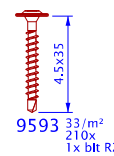

Alle gegevens zijn ter goede trouw en weerspiegelen onze huidige kennis. Zij kunnen derhalve niet tegen ons gebuikt worden. Technische wijzigingen voorbehouden. Tous les renseignements donnés reflètent l'état actuel de nos connaissances et ne peuvent en aucun cas être retenus contre nous. Modifications techniques réservées.

B-04/11-84799-9002-8123

KIUZO 38

MASS COLOURED

deceunick STRUCTURE METALLIC woodgrains STRUCTURE

P	#/m ²
90	8m/m ²
3563	4m/m ²
3564	6.66m/m ²
3565	25m/m ²
3580	3.33m/m ²

P	#/m ²	U
90	8m/m ²	1.75W/m ² K
90 +951	8m/m ²	1.81W/m ² K
172	8m/m ²	2.74W/m ² K
172 +173	7m/m ²	2.74W/m ² K

996

HORREN / MOUSTIQUAIRES / INSEKTENSCHUTZ

**VOORZETHORREN / MOUSTIQUAIRES PLACEMENT EXTERIEUR
VORBAU-INSEKTENSCHUTZ**

**INZETHORREN / MOUSTIQUAIRES PLACEMENT INTERIEUR
EINSATZ INSEKTENSCHUTZ**

**PANEELPROFIELEN
PROFILES PANNEAUX
PANEELPROFIELEN**

P	#/m ²	U
90	8m/m ²	1.75W/m ² K
90 +951	8m/m ²	1.81W/m ² K
172	8m/m ²	2.74W/m ² K
172 +173	7m/m ²	2.74W/m ² K

**HOEKPROFIELEN
PROFILES EQUERRES
ECKLEISTEN**

Alle gegevens zijn ter goede trouw en weerspiegelen onze huidige kennis. Zij kunnen de facto niet tegen ons gebruikt worden. Technische wijzigingen voorbehouden. Tous les renseignements donnés reflètent l'état actuel de nos connaissances et ne peuvent en aucun cas être retenus contre nous. Modifications techniques réservées.



RAAMUITBEKLEDING / EBRASEMENTS / INNERFUTTER

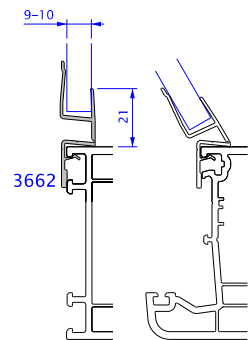
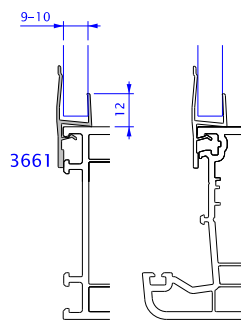
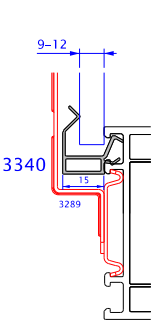
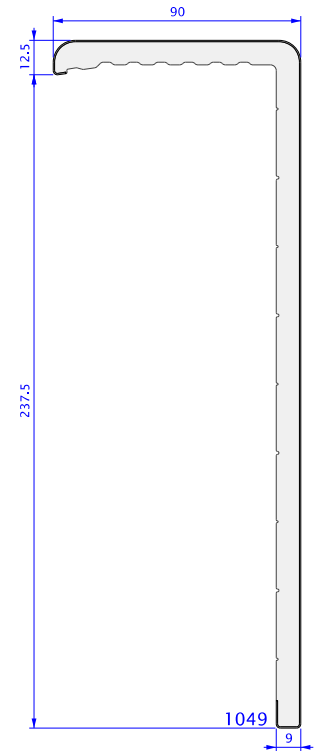
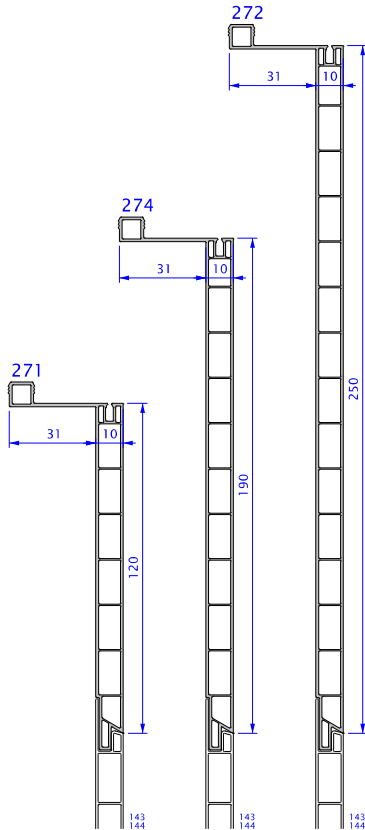
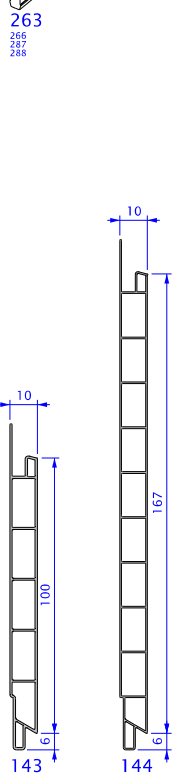
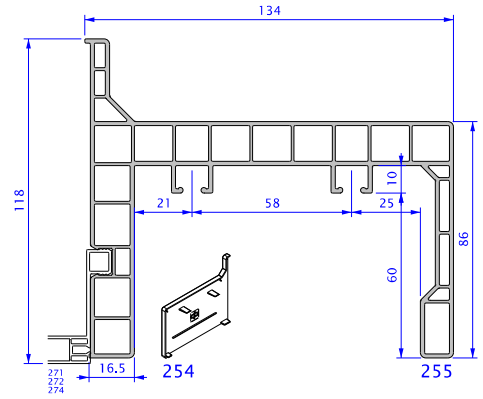
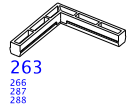
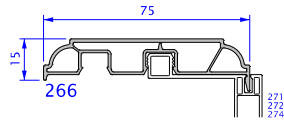
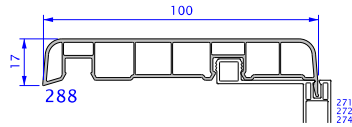
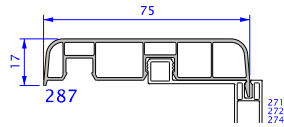

NOVASIL

BINNENVENSTERBANKEN / TABLETTES INTERIEURES
FENSTERTABLETTEN

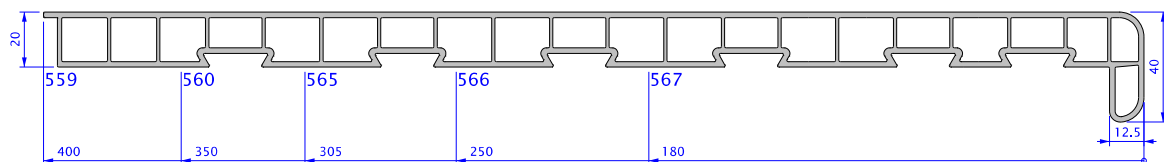

Alle gegevens zijn ter goede trouw en weerspiegelen onze huidige kennis. Zij kunnen deels niet tegen ons gebruikt worden. Technische wijzigingen voorbehouden. / Tous les renseignements donnés reflètent l'état actuel de nos connaissances et ne peuvent en aucun cas être rétenus contre nous. Modifications techniques réservées.

B-06/10-84805-9002-8123

O-TERRACE+

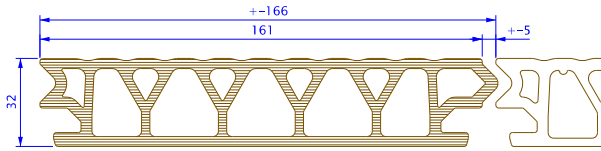

9520
 modulemaat: +166mm
 cote de module: +166mm
 aantal: 6m/m²
 nombre: 6m/m²
 gewicht: +18kg/m²
 poids: +18kg/m²



9512 RVS/INOX DIN A4, AISI 316
 10x

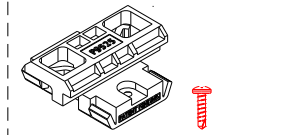

9525 **9546** M4x13

9494 100x 9525
 100x 9546
 1x bit PH2
 +8m²

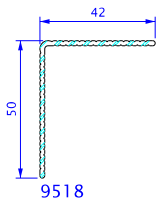

9518

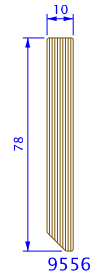

9556

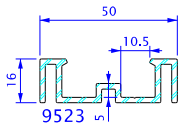

9523

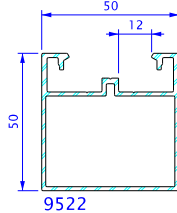

9522

O-TERRACE

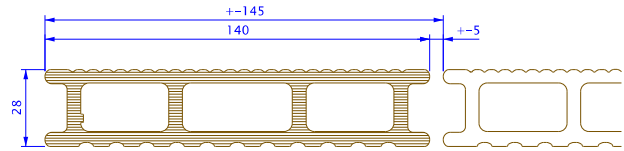

9555
 modulemaat: +145mm
 cote de module: +145mm
 aantal: 7m/m²
 nombre: 7m/m²
 gewicht: +18kg/m²
 poids: +18kg/m²



9512 RVS/INOX DIN A4, AISI 316
 10x

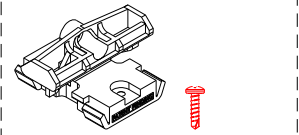

9528 **9546** M4x13

9486 85x 9528
 100x 9546
 1x bit PH2
 +6m²

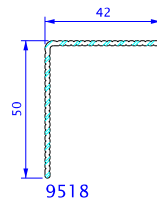

9518

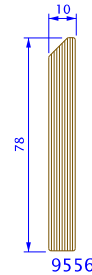

9556

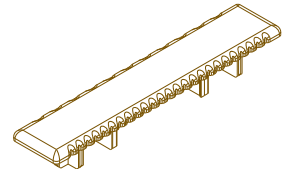

9557

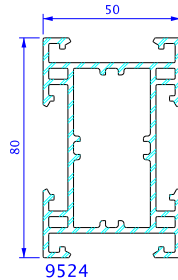

9524

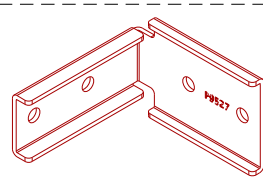

9527 RVS/INOX DIN A2, AISI 304
9531 RVS/INOX DIN A4, AISI 316



9515 M10x16

9495 10x 9527 RVS/INOX DIN A2, AISI 304
 40x 9515
9496 10x 9531 RVS/INOX DIN A4, AISI 316
 40x 9515

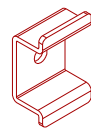

9514 RVS/INOX DIN A2, AISI 304



9515 M10x16

9489 10x 9514 RVS/INOX DIN A2, AISI 304
 10x 9515



2753 4.5x35
 100x
 1x SR2 bit
9546 M4x13
 100x

O-TERRACE+

houten onderstructuur
 sous-structure en bois



9526 100x 9526
 +8m²

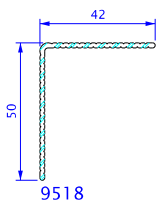

9518

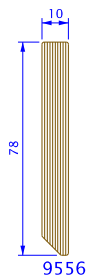

9556

O-TERRACE

houten onderstructuur of P9552
 sous-structure en bois ou P9552

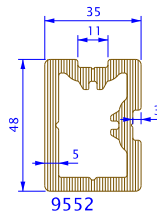

9552

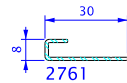

2761

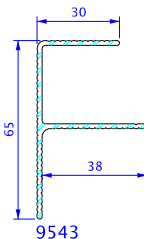

9543

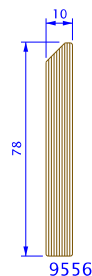

9556

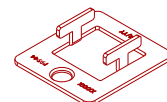

9544 RVS/INOX DIN A2, AISI 304
9554 RVS/INOX DIN A4, AISI 316



9542 4.5x25

9490 100x 9544 RVS/INOX DIN A2, AISI 304
 110x 9542
 1x bit SR2
9491 100x 9554 RVS/INOX DIN A4, AISI 316
 110x 9542
 1x bit SR2
9498 600x 9544 RVS/INOX DIN A2, AISI 304
 650x 9542
 3x bit SR2

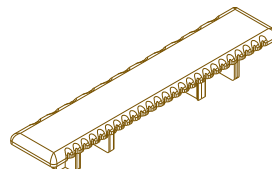

9557