

Essential

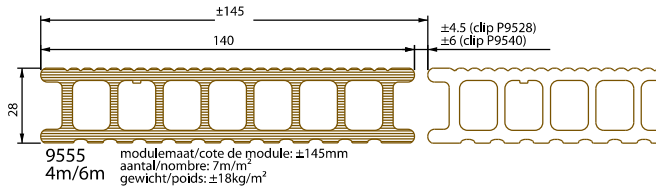

Aluminium onderstructuur / Sous-structure en aluminium

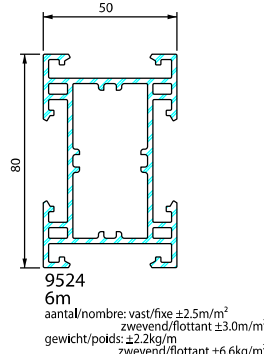
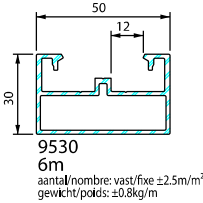
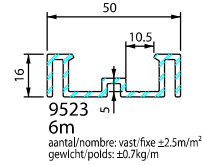
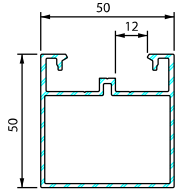

HOEKVERBINDER VOOR P9524 RACCORD MECANIQUE POUR P9524

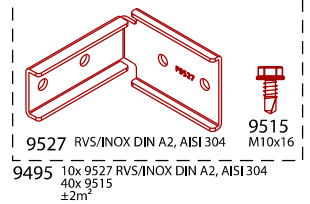

T-VERBINDER VOOR P9522 RACCORD MECANIQUE POUR P9522

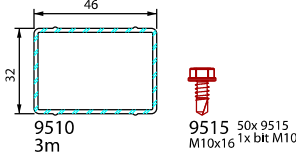
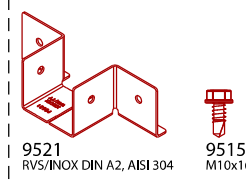

KOPPELING VOOR VAKWERK P9524 ACCOUPEMENT POUR CADRE P9524

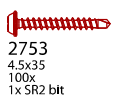
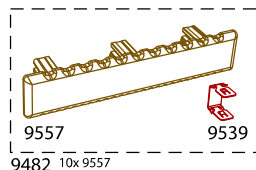
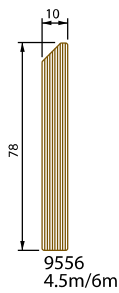
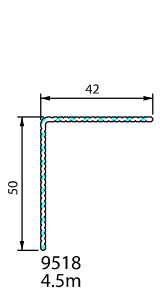
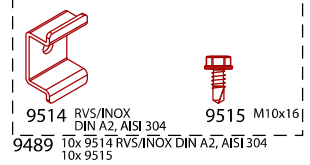

STARTCLIP CLIP DE DEPART	STANDAARD MONTAGECLIP CLIP DE MONTAGE STANDARD	EINDCLIP CLIP DE FINITION
9512 RVS/INOX DIN A4, AISI 316 10x	9528 85x 9528 (=±5.5m ²) 100x 9546 3.5x13 1x bit TX10	9512 RVS/INOX DIN A4, AISI 316 10x

Houten onderstructuur / Sous-structure en bois

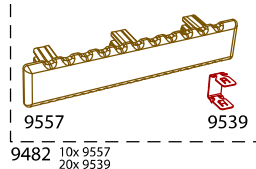
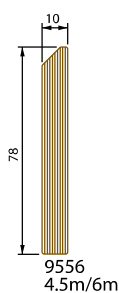
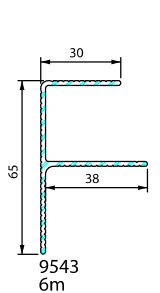

STARTPROFIEL PROFILE DE DEPART	STANDAARD MONTAGECLIP CLIP DE MONTAGE STANDARD	EINDCLIP CLIP DE FINITION
9542 4.5x25 110x	9540 100x 9540 (=±6.5m ²) 120x 9538 1x bit TX15	9529 RVS/INOX DIN A4, AISI 316 4.5x25 9542 4.5x25 9481 10x 9529 10x 9542
	9484 600x 9540 (=±37.5m ²) 720x 9538 1x bit TX15	

Tegeldragers / Plots

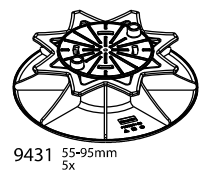
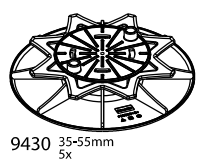
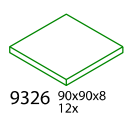

Terras / Terrasse

Tuintoepassingen / Aménagement extérieur



Deceuninck nv - Benelux

Bruggesteenweg 360 - B-8830 Hooglede-Gits
(BE) T + 32 51 239 272 - belux@deceuninck.com - www.deceuninck.be
(NL) T + 31 76 561 78 34 - deceuninck.kunststof@deceuninck.com - www.deceuninck.nl

Building a sustainable home

Alle gegevens zijn ter goede trouw en weerspiegelen onze huidige kennis. Zij kunnen deeltijde niet tegen ons gebruikt worden. Technische wijzigingen voorbehouden. Tous les renseignements donnés reflètent l'état actuel de nos connaissances et ne peuvent en aucun cas être retenus contre nous. Modifications techniques réservées.

B-10/20-84801-8123

Essential XL

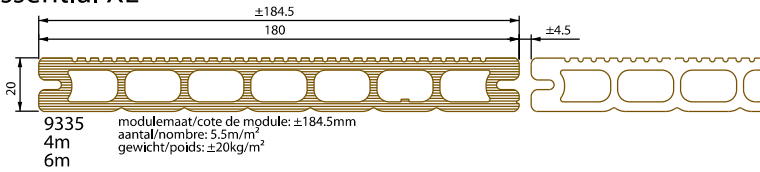

Aluminium onderstructuur / Sous-structure en aluminium

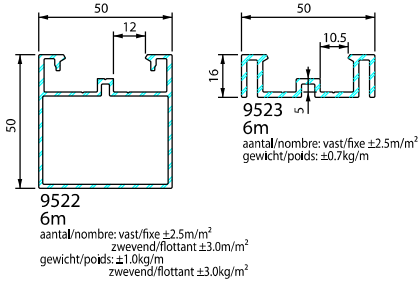

T-VERBINDER VOOR P9522
RACCORD MECANIQUE POUR P9522

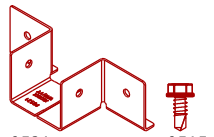

9468 10x 9521 RV5/INOX DIN A2, AISI 304
40x 9515 ±3.5m²

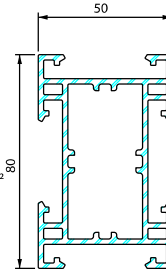
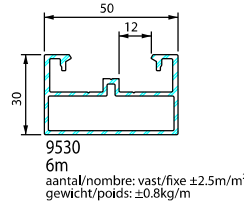
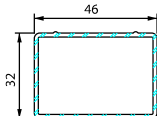

HOEKVERBINDER VOOR P9524
RACCORD MECANIQUE POUR P9524

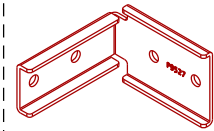

9495 10x 9527 RV5/INOX DIN A2, AISI 304
40x 9515 ±2m²

KOPPELING VOOR VAKWERK P9524
ACCOUPEMENT POUR CADRE P9524



9489 10x 9514 RV5/INOX DIN A2, AISI 304
10x 9515

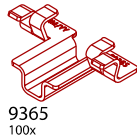
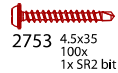
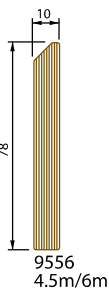
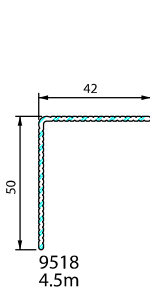

STARTPROFIEL PROFILE DE DEPART	STANDAARD MONTAGECLIP CLIP DE MONTAGE STANDARD	EINDPROFIEL PROFILE DE FINITION
	9469 100x 9342 (= ±6.5m ²) 110x 9546 1x bit TX10	

Houten onderstructuur / Sous-structure en bois

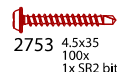
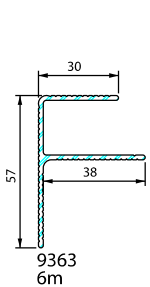

STARTPROFIEL PROFILE DE DEPART	STANDAARD MONTAGECLIP CLIP DE MONTAGE STANDARD	EINDPROFIEL PROFILE DE FINITION
	9477 100x 9364 (= ±6.5m ²) 110x 9542 1x bit R2	

Tegeldragers / Plots

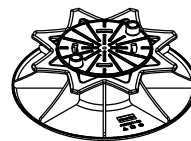
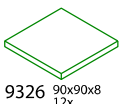

Terras / Terrasse

Tuintoepassingen / Aménagement extérieur



Deceuninck nv - Benelux

Bruggesteenweg 360 - B-8830 Hooglede-Gits

(BE) T + 32 51 239 272 - belux@deceuninck.com - www.deceuninck.be

(NL) T + 31 76 561 78 34 - deceuninck.kunststof@deceuninck.com - www.deceuninck.nl

Building a sustainable home

Alle gegevens zijn ter goede trouw en weerspiegelen onze huidige kennis. Zij kunnen deels niet tegen ons gebruikt worden. Technische wijzigingen voorbehouden. Tous les renseignements donnés reflètent l'état actuel de nos connaissances et ne peuvent en aucun cas être retenus contre nous. Modifications techniques réservées.

B-10/20-8123

Character Massive

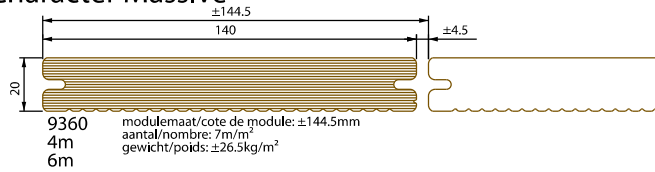

Aluminium onderstructuur / Sous-structure en aluminium

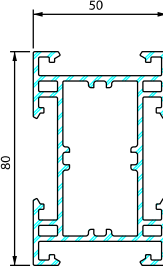
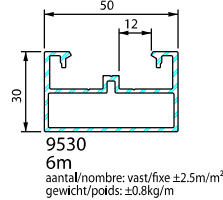
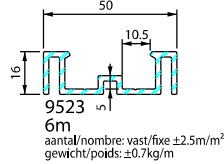
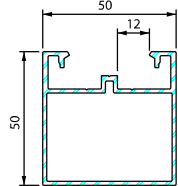

HOEKVERBINDER VOOR P9524 RACCORD MECANIQUE POUR P9524

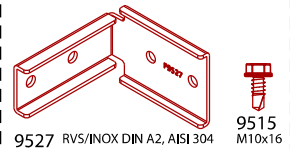

9495 10x 9527 RVS/INOX DIN A2, AISI 304 40x 9515 ±2m²

KOPPELING VOOR VAKWERK P9524 ACCOUPLLEMENT POUR CADRE P9524



9489 10x 9514 RVS/INOX DIN A2, AISI 304 10x 9515

T-VERBINDER VOOR P9522 RACCORD MECANIQUE POUR P9522

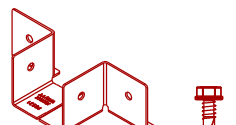

9468 10x 9521 RVS/INOX DIN A2, AISI 304 40x 9515 ±3.5m²

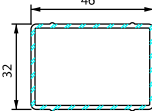

9515 50x 9515 M10x16 1x bit M10

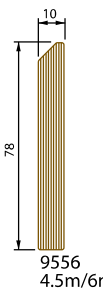
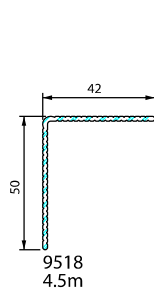

2753 4.5x35 100x 1x SR2 bit

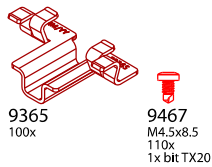

STARTPROFIEL PROFILE DE DEPART	STANDAARD MONTAGECLIP CLIP DE MONTAGE STANDARD	EINDPROFIEL PROFILE DE FINITION
 9366 3m	 9342 9546 110x 9346 3.5x13 9469 100x 9342 (= ±6.5m ²) 110x 9546 1x bit TX10	 9366 3m
 9542 4.5x25 110x	 9542 4.5x25 110x	 9542 4.5x25 110x

Houten onderstructuur / Sous-structure en bois

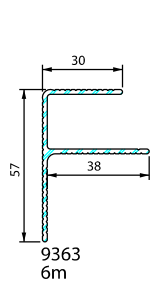

2753 4.5x35 100x 1x SR2 bit

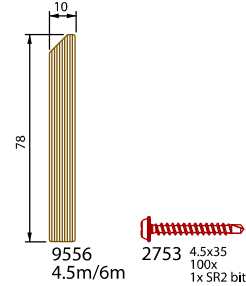

2753 4.5x35 100x 1x SR2 bit

STARTPROFIEL PROFILE DE DEPART	STANDAARD MONTAGECLIP CLIP DE MONTAGE STANDARD	EINDPROFIEL PROFILE DE FINITION
 9366 3m	 9364 9542 110x 9364 (= ±6.5m ²) 110x 9542 1x bit R2	 9366 3m
 9542 4.5x25 110x	 9542 4.5x25 110x	 9542 4.5x25 110x

Tegeldragers / Plots

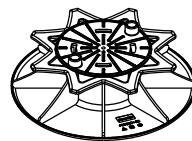

Terras / Terrasse

Tuintoepassingen / Aménagement extérieur



Deceuninck nv - Benelux

Bruggesteenweg 360 - B-8830 Hooglede-Gits

(BE) T + 32 51 239 272 - belux@deceuninck.com - www.deceuninck.be

(NL) T + 31 76 561 78 34 - deceuninck.kunststof@deceuninck.com - www.deceuninck.nl

Building a sustainable home

Majestic Massive Pro

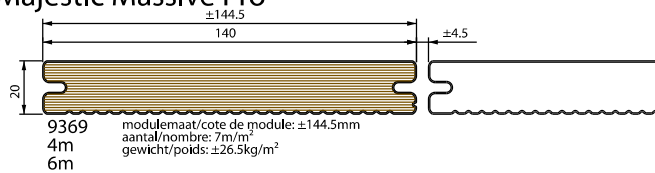

9369
4m
6m
modulemaat/cote de module: ±144.5mm
aantal/nombre: 7m/m²
gewicht/poids: ±26.5kg/m²

Aluminium onderstructuur / Sous-structure en aluminium

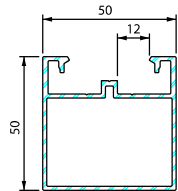

9522
6m
aantal/nombre: vast/fixe ±2.5m/m²
zwevend/flottant ±3.0m/m²
gewicht/poids: ±1.0kg/m
zwevend/flottant ±3.0kg/m

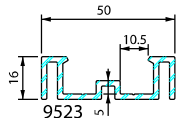

9523
6m
aantal/nombre: vast/fixe ±2.5m/m²
gewicht/poids: ±0.7kg/m

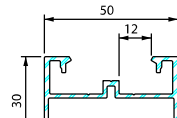

9530
6m
aantal/nombre: vast/fixe ±2.5m/m²
gewicht/poids: ±0.8kg/m

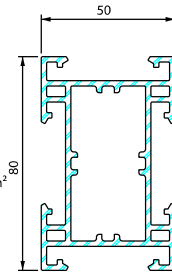

9524
6m
aantal/nombre: vast/fixe ±2.5m/m²
zwevend/flottant ±3.0m/m²
gewicht/poids: ±2.2kg/m
zwevend/flottant ±6.6kg/m

T-VERBINDER VOOR P9522
RACCORD MECANIQUE POUR P9522

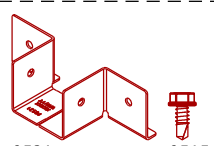

9521 RVS/INOX DIN A2, AISI 304 M10x16
9515
9468 10x 9521 RVS/INOX DIN A2, AISI 304
40x 9515
±3.5m

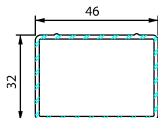

9510
3m
9515 50x 9515
M10x16 1x bit M10

HOEKVERBINDER VOOR P9524
RACCORD MECANIQUE POUR P9524

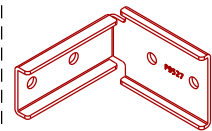

9515 M10x16
9527 RVS/INOX DIN A2, AISI 304
9495 10x 9527 RVS/INOX DIN A2, AISI 304
40x 9515
±2m

KOPPELING VOOR VAKWERK P9524
ACCOUPLLEMENT POUR CADRE P9524



9514 RVS/INOX DIN A2, AISI 304
9515 M10x16
9489 10x 9514 RVS/INOX DIN A2, AISI 304
10x 9515

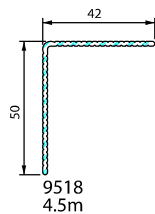

9518
4.5m
2753 4.5x35
100x
1x SR2 bit

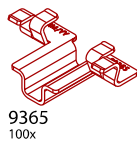

9365
100x
9467 M4.5x8.5
110x
1x bit TX20

STARTPROFIEL PROFILE DE DEPART	STANDAARD MONTAGECLIP CLIP DE MONTAGE STANDARD	EINDPROFIEL PROFILE DE FINITION
9366 3m	9342 9546 100x 9342 (= ±6.5m ²) 110x 9546 1x bit TX10	9366 3m
9542 4.5x25 110x	9542 4.5x25 110x	9542 4.5x25 110x

Houten onderstructuur / Sous-structure en bois

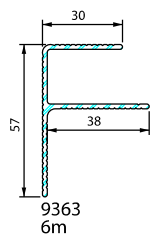

9363
6m
2753 4.5x35
100x
1x SR2 bit
9542 4.5x25
110x

STARTPROFIEL PROFILE DE DEPART	STANDAARD MONTAGECLIP CLIP DE MONTAGE STANDARD	EINDPROFIEL PROFILE DE FINITION
9366 3m	9364 9477 100x 9364 (= ±6.5m ²) 110x 9542 1x bit R2	9366 3m
9542 4.5x25 110x	9542 4.5x25 110x	9542 4.5x25 110x

Tegeldragers / Plots

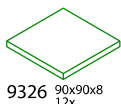

9326 90x90x8
12x



9430 35-55mm
5x



9431 55-95mm
5x



9429 40mm
25x

Alle gegevens zijn ter goede trouw en weerspiegelen onze huidige kennis. Zij kunnen deels niet tegen ons gebruikt worden. Technische wijzigingen voorbehouden. Tous les renseignements donnés reflètent l'état actuel de nos connaissances et ne peuvent en aucun cas être retenus contre nous. Modifications techniques réservées.

B-10/20-8123

Terras / Terrasse

Tuintoepassingen / Aménagement extérieur



Deceuninck nv - Benelux

Bruggesteenweg 360 - B-8830 Hooglede-Gits

(BE) T + 32 51 239 272 - belux@deceuninck.com - www.deceuninck.be

(NL) T + 31 76 561 78 34 - deceuninck.kunststof@deceuninck.com - www.deceuninck.nl

Building a sustainable home

SERIE			
1030	1156 500mm sym 300mm	1157 300mm	1155 500mm sym 300mm
1400	1406 500mm sym	1407 300mm	1408 500mm sym

P			
104	160	162	161
131	157 480mm sym	178 480mm sym	177 480mm sym
133	166	178 480mm sym	177 480mm sym
156	157 480mm sym	178 480mm sym	177 480mm sym
183	157 480mm sym	178 480mm sym	177 480mm sym
185	160	162	161

P	#/m ²
130	6m/m ²
144	6m/m ²
153	4m/m ²
180	10m/m ²

P			
129	163	164	171
155	175	176	
182	175	176	

Alle gegevens zijn ter goede trouw en weerspiegelen onze huidige kennis. Zij kunnen deels niet tegen ons gebruikt worden. Technische wijzigingen voorbehouden.
 Tous les renseignements donnés reflètent l'état de nos connaissances et ne peuvent en aucun cas être retenus contre nous. Modifications techniques réservées.

B-08/20-84/64-81.23

Dakgootbekleding / Habillage de chéneaux Dak & gevel / Bardage & sous-toitures



Deceuninck nv - Benelux
 Bruggesteeweg 360 - B-8830 Hooglede-Gits
 (BE) T + 32 51 239 272 - belux@deceuninck.com - www.deceuninck.be
 (NL) T + 31 76 561 78 34 - deceuninck.kunststof@deceuninck.com - www.deceuninck.nl

Addendum affiche Dakgootbekleding/Habillage de chéneaux

0 008

**gekleurd in de massa donkerbruin RAL ±8022
teintée dans la masse brun foncé RAL ±8022**

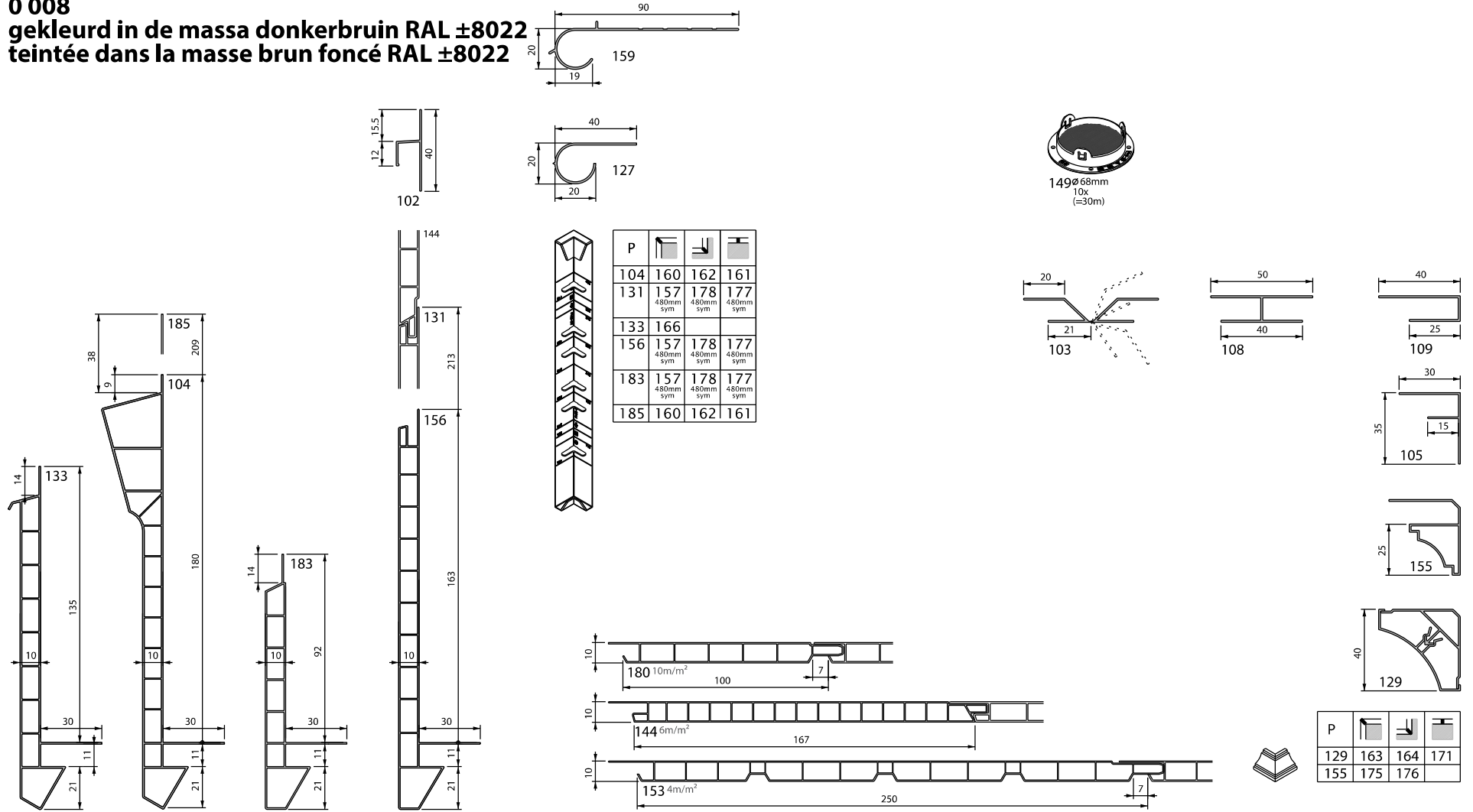

Alle gegevens zijn ter goede trouw en weerspiegelen onze huidige kennis. Zij kunnen deels niet tegen ons gebruikt worden. Technische wijzigingen voorbehouden. Tous les renseignements donnés relèvent de nos connaissances et ne peuvent en aucun cas être retenus contre nous. Modifications techniques réservées.

B-09/20

Addendum affiche Dakgootbekleding/Habillage de chéneaux 0 072 gekleurd in de massa antracietgrijs RAL ±7016 teintée dans la masse gris anthracite RAL ±7016

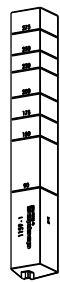
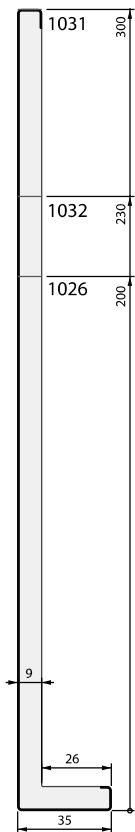

SERIE	1030	1159	1157	1158
	300mm	300mm	300mm	300mm

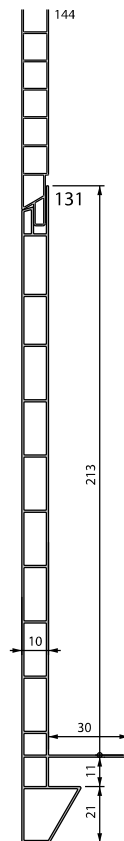

P	131	157	178	177
	480mm sym	480mm sym	480mm sym	480mm sym

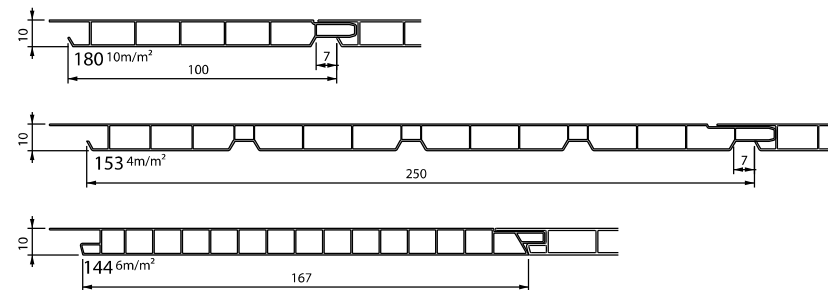
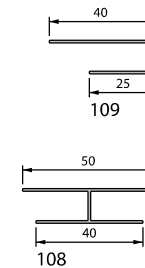

Dakgootbekleding / Habillage de chéneaux

Dak & gevel / Bardage & sous-toitures



Deceuninck nv - Benelux

Bruggesteeweg 360 - B-8830 Hooglede-Gits

(BE) T + 32 51 239 272 - F + 32 51 239 261 - belux@deceuninck.com - www.deceuninck.be

(NL) T + 31 76 561 78 34 - F + 31 76 75 02 353 - deceuninck.kunststof@deceuninck.com - www.deceuninck.nl

Building a sustainable home

Addendum affiche Dakgootbekleding/Habillage de chéneaux

0 096

gekleurd in de massa crème wit RAL±9001
teintée dans la masse blanc crème RAL±9001

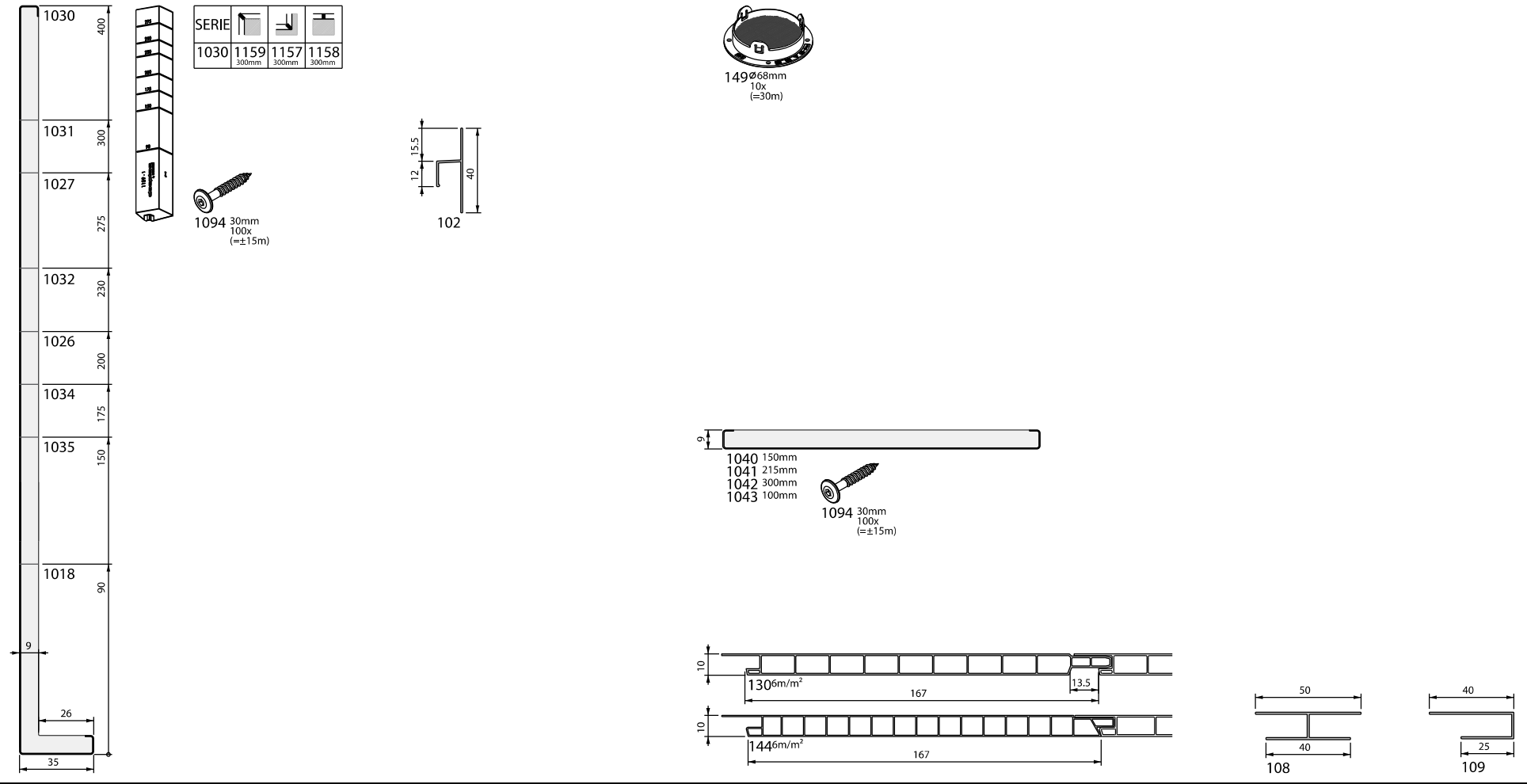





Alle gegevens zijn ter goede trouw en weerspiegelen onze huidige kennis. Zij kunnen derhalve niet tegen ons gebruikt worden. Technische wijzigingen voorbehouden. Tous les renseignements donnés reflètent l'état actuel de nos connaissances et ne peuvent en aucun cas être retenus contre nous. Modifications techniques réservées.

B-09/20

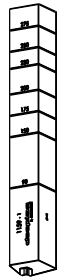
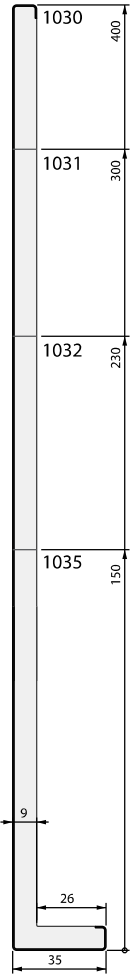
Addendum affiche Dakgootbekleding/Habillage de chéneaux

1 ... structuurafwerking finition filmée



SERIE			
1030	1159 300mm		1158 300mm

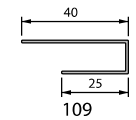
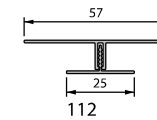
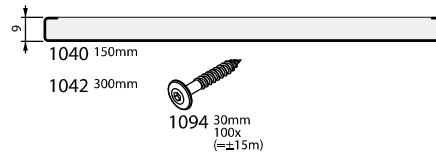

Alle gegevens zijn ter goede trouw en weerspiegelen onze huidige kennis. Zij kunnen derhalve niet tegen ons gebruikt worden. Technische wijzigingen voorbehouden.
Tous les renseignements donnés reflètent l'état actuel de nos connaissances et ne peuvent en aucun cas être retenus contre nous. Modifications techniques réservées.

B-09/20

Dakgootbekleding / Habillage de chéneaux

Dak & gevel / Bardage & sous-toitures



Deceuninck nv - Benelux

Bruggesteenweg 360 - B-8830 Hooglede-Gits

(BE) T + 32 51 239 272 - F + 32 51 239 261 - belux@deceuninck.com - www.deceuninck.be

(NL) T + 31 76 561 78 34 - F + 31 76 75 02 353 - deceuninck.kunststof@deceuninck.com - www.deceuninck.nl

Building a sustainable home

Addendum affiche Dakgootbekleding/Habillage de chéneaux

6 ... decoroc coating

* De artikelen aangeduid in blauw zijn enkel beschikbaar in 6068, 6072 en 6096
 * Les articles colorés en bleu ne sont disponible qu'en 6068, 6072 et 6096

SERIE	1156	1155
1030	500mm sym	500mm sym
	1159	1158
	300mm	300mm

P	131*	157*	178*	177*
	157, 177, 178 = 480mm			

1094 30mm 100x (≈±15m)

1094 30mm 100x (≈±15m)

1040 150mm
1042 300mm

1094 30mm 100x (≈±15m)

149 ∅68mm 10x (=30m)

18010m/m²

1446m/m²

Alle gegevens zijn ter goede trouw en weerspiegelen onze huidige kennis. Zij kunnen de halve niet tegen ons gebruikt worden. Technische wijzigingen voorbehouden. Tous les renseignements donnés relèvent de l'état actuel de nos connaissances et ne peuvent en aucun cas être retenus contre nous. Modifications techniques réservées.

B-09/20

Rabat 150 Elégie 150 (P 2750)			Potdeksel 167 Clin 167 structuré (P 1036)			Dubbele rabat 300 Double clin structuré 300 (P 1024)				
2750 6.6m ² 6m 5.6kg/m ²			1036 6m/m ² 6m 4.6kg/m ²			1024 3.33m/m ² 6m 4.6kg/m ²				
2753 100x 1x bit R2 (wit/blanc = ±8m ²) (couleur = ±4m ²)			1096 250x (±20m ²)			1096 250x (±38m ²)				
2754 100x 1x bit R2 (wit/blanc = ±83m²) (couleur = ±41,5m²)										
1025 250x (±20m ²)			1025 250x (±20m ²)			(2x) 1021 6m				
P	#/m ²		P	#/m ²		P	#/m ²			
2750	6.6m ²	5.6kg/m ²	1036	6m/m ²	4.6kg/m ²	1036	3.33m/m ²	4.6kg/m ²		
2753	±12/m ²		1096	±20/m ²		1096	±7/m ²			
2754	±24/m ² (003/wit/blanc (4eur/couleur)									
2762	±2.2/m ²		1037	±2/m ²		1029	±1.1/m ²			
		5.6kg/m ²			4.6kg/m ²			4.6kg/m ²		

Alle gegevens zijn ter gade trouw en weerspiegelen onze huidige kennis. Zij kunnen deeltalve niet tegen ons gebruikt worden. Technische wijzigingen voorbehouden.
 Tous les renseignements données reflètent l'état actuel de nos connaissances et ne peuvent en aucun cas être retenus contre nous. Modifications techniques réservées.

B-01/21-84803-8123

Vlak 200 (P 2730)
Lisse 200 (P 2730)

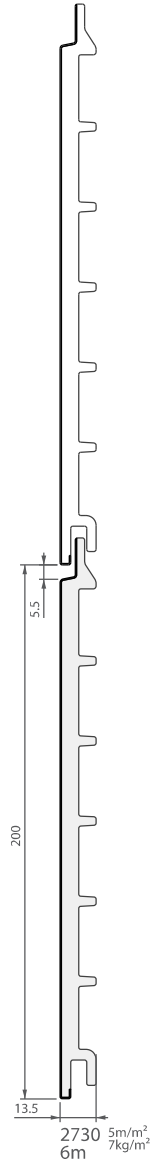

P	#/m ²	
2730	5m/m ²	7kg/m ²
2736	±10/m ²	
2732	±20/m ²	
2733	±1.5/m ²	7kg/m ²

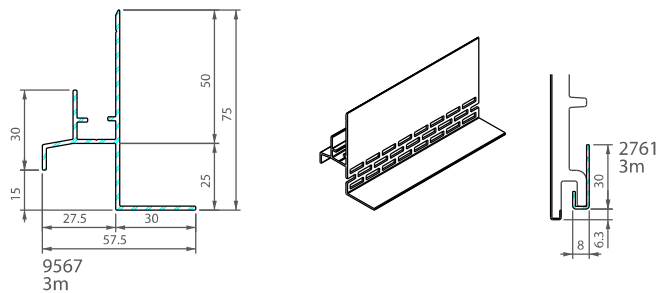
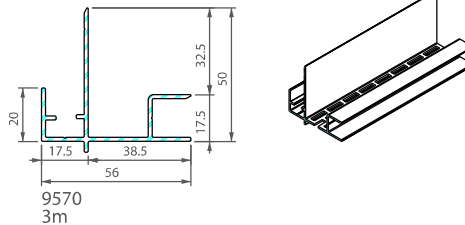
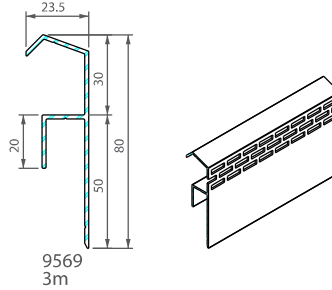
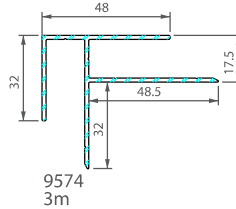
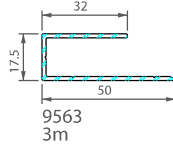
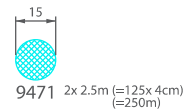
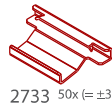
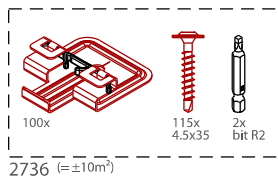
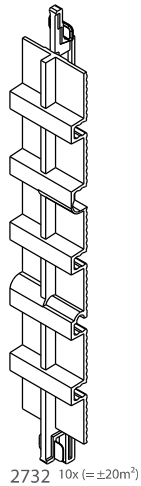

B-10/20-85671-8123 Alle gegevens zijn ter goede trouw en weerspiegelen onze huidige kennis. Zij kunnen deeltalve niet tegen ons gebruikt worden. Technische wijzigingen voorbehouden. Tous les renseignements donnés reflètent l'état actuel de nos connaissances et ne peuvent en aucun cas être retenus contre nous. Modifications techniques réservées.

Premium

Dak & gevel / Bardage & sous-toitures



Deceuninck nv - Benelux

Bruggesteenweg 360 - B-8830 Hooglede-Gits

(BE) T + 32 51 239 272 - belux@deceuninck.com - www.deceuninck.be

(NL) T + 31 76 561 78 34 - deceuninck.kunststof@deceuninck.com - www.deceuninck.nl

Building a sustainable home

Vlak 167 alu (P 9579)
Lisse 167 alu (P 9579)

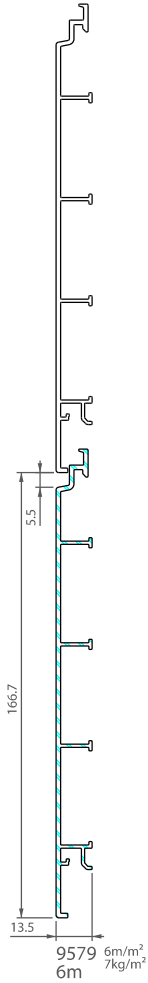

P	#/m ²	
9579	6m/m ²	7kg/m ²
9588	±12/m ²	
9595	±2/m ²	
9573	±1/m ²	
		7kg/m ²

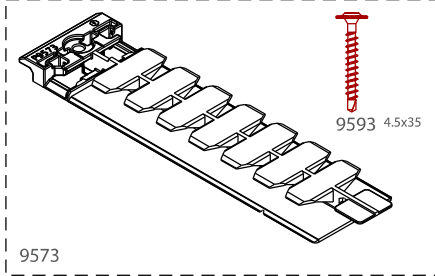
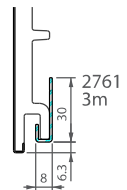
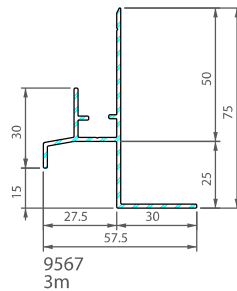
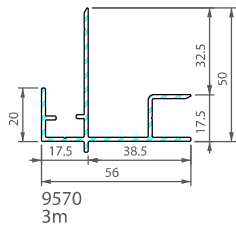
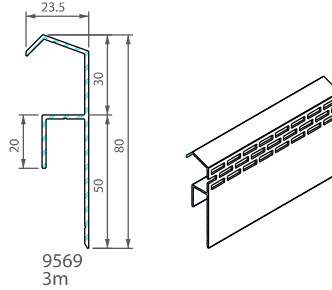
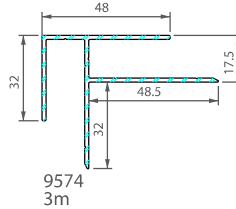
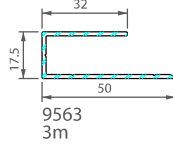

9573
9499 20x 9573 (=±20m²)
21x 9593

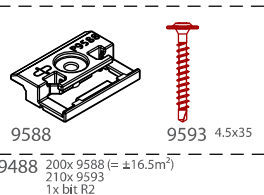

9588
9488 200x 9588 (= ±16.5m²)
210x 9593
1x bit R2

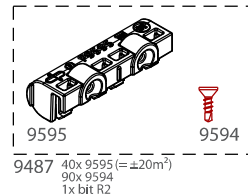

9595
9487 40x 9595 (= ±20m²)
90x 9594
1x bit R2

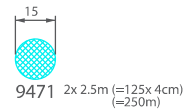

9471 2x 2.5m (=125x 4cm)
(=250m)

Alle gegevens zijn ter goede trouw en weerspiegelen onze huidige kennis. Zij kunnen deeltijde niet tegen ons gebruikt worden. Technische wijzigingen voorbehouden. Tous les renseignements donnés reflètent l'état actuel de nos connaissances et ne peuvent en aucun cas être retenus contre nous. Modifications techniques réservées.

Premium

Dak & gevel / Bardage & sous-toitures



Deceuninck nv - Benelux

Bruggesteenweg 360 - B-8830 Hooglede-Gits

(BE) T + 32 51 239 272 - belux@deceuninck.com - www.deceuninck.be

(NL) T + 31 76 561 78 34 - deceuninck.kunststof@deceuninck.com - www.deceuninck.nl

Building a sustainable home

Rabat 150 (P 2750)
Elégie 150 (P 2750)

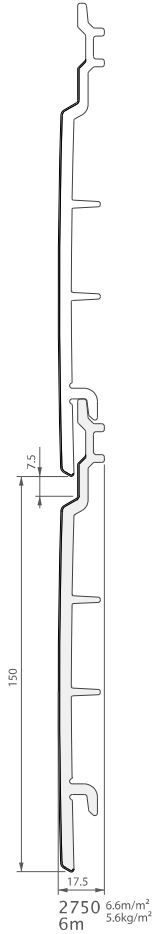





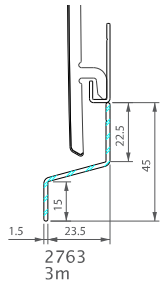

P	#/m ²	
2750	6.6m ² /m ²	5.6kg/m ²
2753/2754	±24/m ²	
2762	±2.2/m ²	5.6kg/m ²

2750 6.6m²/m²
6m 5.6kg/m²

 4.5x25
2753 100x 1x bit R2 (=±4m²)
2754 1000x 1x bit R2 (=±41.5m²)



	<p>2755 3m 2758 3m</p>
	<p>2759 3m 2760 3m</p> <p>2762 1x ±2.2/m²</p>
	<p>2755 3m 2756 3m</p>
	<p>2755 3m 2757 3m</p>
	<p>2755 3m 2758 3m</p>
	<p>2761 3m</p>

Alle gegevens zijn ter goede trouw en weerspreken onze huidige kennis. Zij kunnen deels niet tegen ons gebruikt worden. Technische wijzigingen voorbehouden.
Tous les renseignements données reflètent l'état de nos connaissances et ne peuvent en aucun cas être utilisés contre nous. Modifications techniques réservées.

B-05/14-84800-8123

Premium

Dak & gevel / Bardage & sous-toitures



Deceuninck nv - Benelux

Bruggesteenweg 360 - B-8830 Hoogde-Gits

(BE) T + 32 51 239 272 - F + 32 51 239 261 - belux@deceuninck.com - www.deceuninck.be

(NL) T + 31 76 561 78 34 - F + 31 76 75 02 353 - deceuninck.kunststof@deceuninck.com - www.deceuninck.nl

Building a sustainable home

Vlak 167 Twinson® (P 9576) Lisse 167 Twinson® (P 9576)

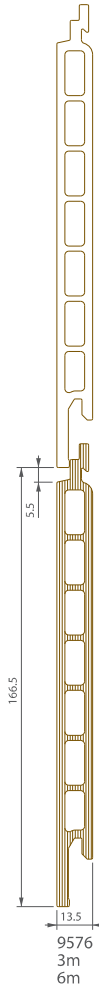

P	#/m ²	
9576	6m/m ²	10kg/m ²
9588	±12/m ²	
9595	±4/m ²	
9573	±2/m ²	
		10kg/m ²

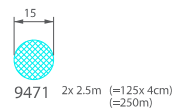
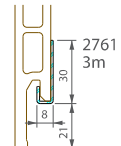
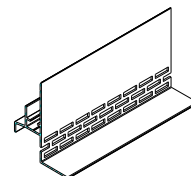
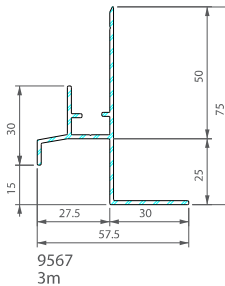
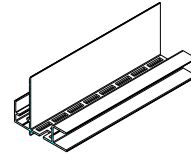
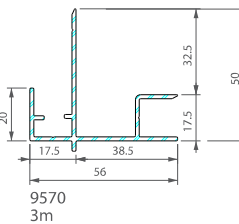
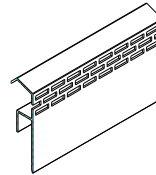
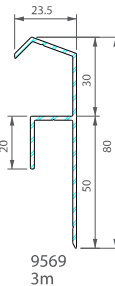
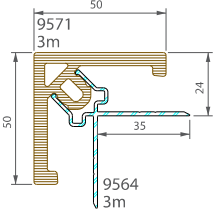
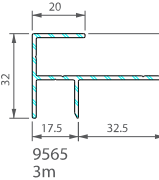
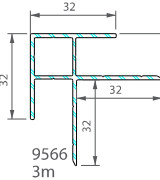
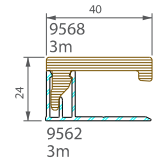
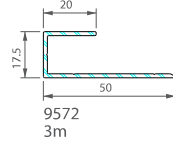
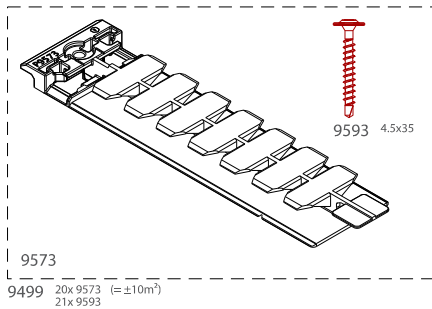
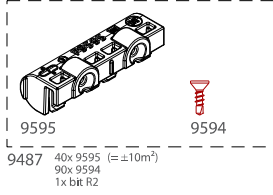
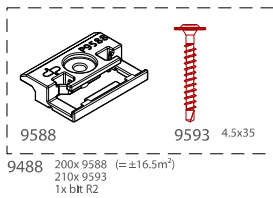

Vlak open 83 Twinson® (P 9596) Ajouré 83 Twinson® (P 9596)

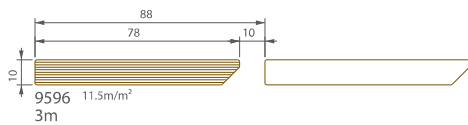

P	#/m ²	
2753	±33/m ²	
2754	±33/m ²	
9593	±33/m ²	
9596	11.5m/m ²	11.5kg/m ²
9598	3.3m/m ²	1.6kg/m ²
		13.1kg/m ²

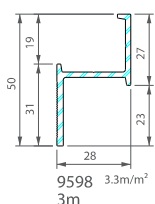
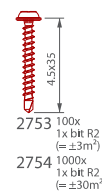
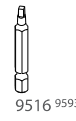
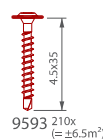

Alle gegevens zijn ter goede trouw en weerspreken onze huidige kennis. Zij kunnen deels niet tegen ons gebuikt worden. **Tous les renseignements données relèvent de notre état de nos connaissances et ne peuvent en aucun cas être utilisés contre nous. Veuillez toujours vérifier les données.**

Premium

Dak & gevel / Bardage & sous-toitures



Deceuninck nv - Benelux

Bruggesteenweg 360 - B-8830 Hooglede-Gits

(BE) T + 32 51 239 272 - F + 32 51 239 261 - belux@deceuninck.com - www.deceuninck.be

(NL) T + 31 76 561 78 34 - F + 31 76 75 02 353 - deceuninck.kunststof@deceuninck.com - www.deceuninck.nl

Building a sustainable home

Wand- en plafondbekleding / Lambris d'intérieur

Primavera

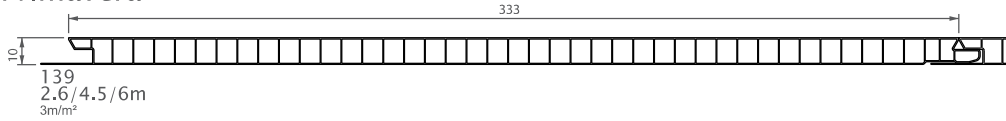

Plinten en sierlijsten / Plinthes et moulures

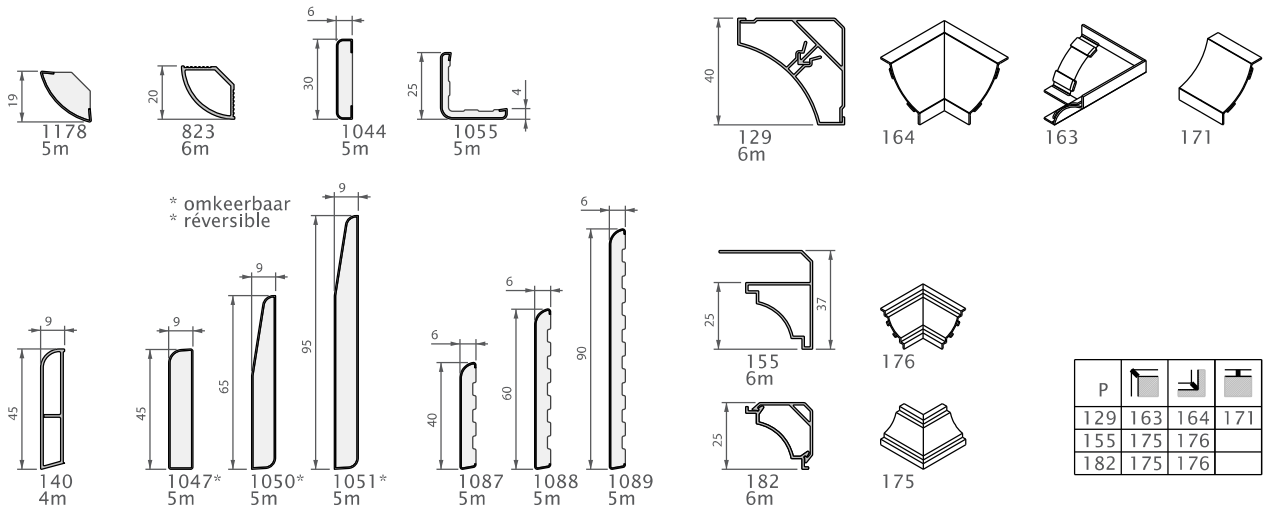

Alle gegevens zijn ter goede trouw en weerspiegelen onze huidige kennis. Zij kunnen deels of geheel niet tegen ons gebruikt worden. Technische wijzigingen voorbehouden.
 Tous les renseignements donnés reflètent l'état actuel de nos connaissances et ne peuvent en aucun cas être retenus contre nous. Modifications techniques réservées.

B-10/20-84798-8123

Interieurtoepassingen / Décoration intérieure



Deceuninck nv - Benelux

Bruggesteenweg 360 - B-8830 Hooglede-Gits

(BE) T + 32 51 239 272 - belux@deceuninck.com - www.deceuninck.be

(NL) T + 31 76 561 78 34 - deceuninck.kunststof@deceuninck.com - www.deceuninck.nl

Building a sustainable home

Raamuitbekleding Ebraseмент

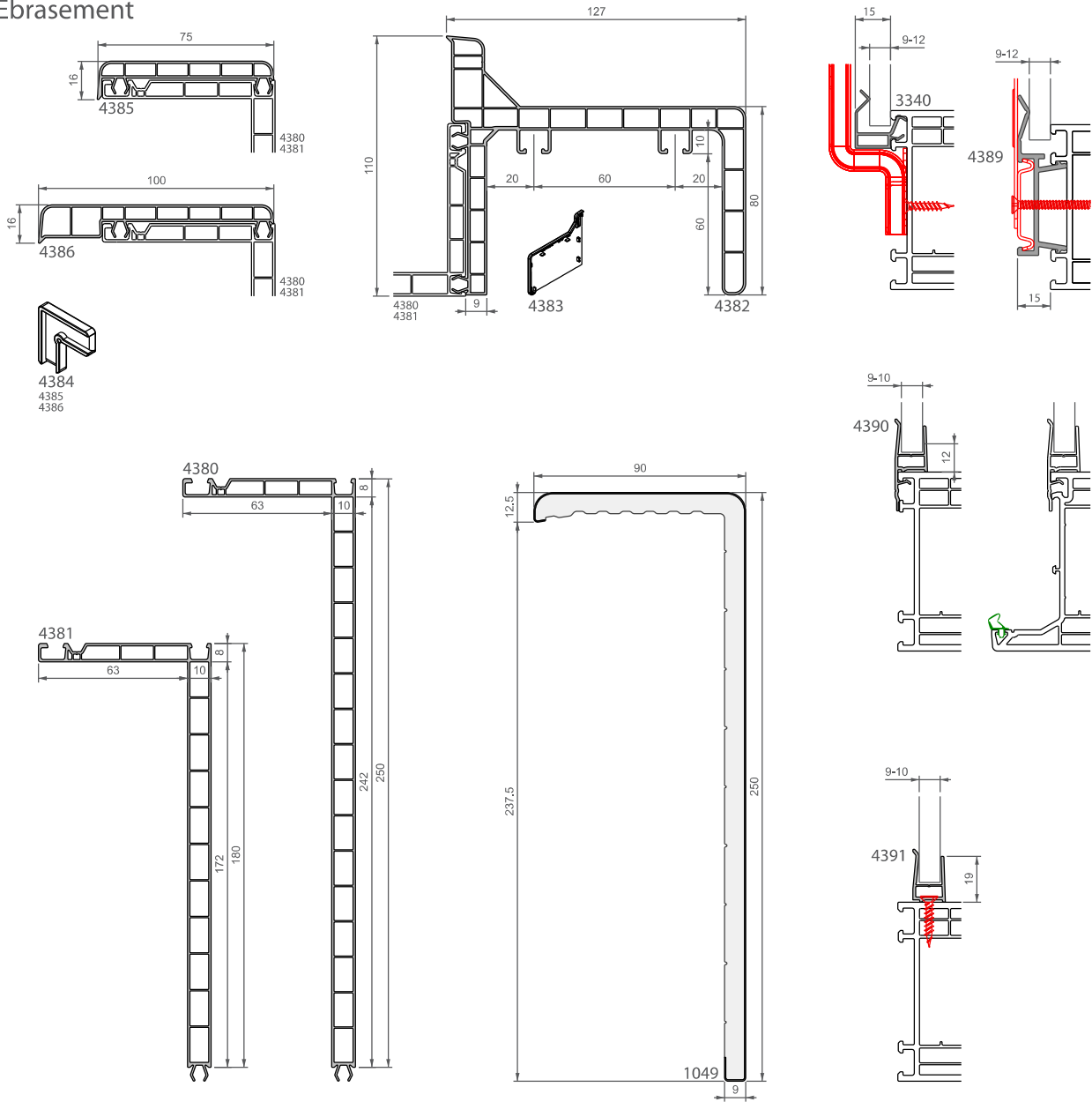

Binnenvensterbanken Tablettes intérieures

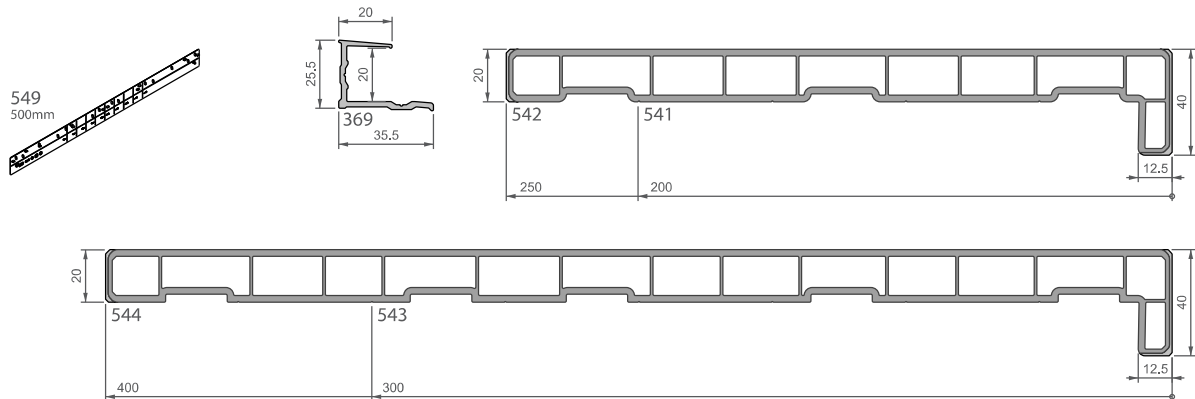

Alle gegevens zijn ter goede trouw en weerspiegelen onze huidige kennis. Zij kunnen derhalve niet teggen ons gebruikt worden. Technische wijzigingen voorbehouden.
Tous les renseignements donnés reflètent l'état actuel de nos connaissances et ne peuvent en aucun cas être retenus contre nous. Modifications techniques réservées.

B-02/20-21700

Raamafwerking / Finition de châssis

Interieurtoepassingen / Décoration intérieure



Deceuninck nv - Benelux

Bruggesteenweg 360 - B-8830 Hoogdele-Gits

(BE) T + 32 51 239 272 - belux@deceuninck.com - www.deceuninck.be

(NL) T + 31 76 561 78 34 - deceuninck.kunststof@deceuninck.com - www.deceuninck.nl

Building a sustainable home